

Foreword

Before using this product

Please read this user manual carefully in order to ensure your safety and the proper operation of this product. Keep for future reference.

Thank you for purchasing a GODOX product.

WITSTRO TTL Powerful & Portable Flash AD360II-C adopts Godox 2.4G wireless X system. When using on the camera, AD360II-C is suitable for Canon EOS cameras; when using Godox 2.4G wireless X system off camera, AD360II-C is compatible with Canon E-TTL II autoflash, Nikon i-TTL autoflash, etc. With master & slave functions, AD360II-C can also use in combination with Godox TTL camera flashes, TTL outdoor flashes, TTL studio flashes, etc. With this AD360II-C flash, your shooting will become simpler. You can easily achieve a correct flash exposure even in complex light-changing environments.

WITSTRO AD360II-C flash system is an AD360II-C flash with a bare tube, external power pack, wireless manual power control, and a range of dedicated light shaping accessories. AD360II-C is 5 to 7 times powerful as typical hotshoe flashes with the size and weight alike. It offers studio quality light for outdoor and live shooting. The AD360II-C offers:

- **Compatible wireless TTL system:** Fully support Canon E-TTL II, Nikon i-TTL and other TTL systems in Godox 2.4G wireless X system. Workable as Master or Slave unit in a wireless flash group.
- **Dot-matrix LCD panel:** with clear and convenient operation.
- **Built-in 2.4G wireless transmission:** with all-in-one functions and 100 meters further transmission with X1 TTL wireless flash trigger.
- **Studio quality light:** up to 360Ws, GN 80 (m ISO 100, with AD-S2 standard reflector) . One AD360II-C can overpower the sun.
- **External battery pack:** PB960 (lithium, 11.1V/4500mAh), 0.05-4.5s recycling and 450 full power flashes.
- **Lightweight and portable** even with power and accessories
- **Wireless control:** With built-in Godox 2.4G wireless X system to achieve TTL control. Godox FT-16 flash trigger can also be used to wirelessly adjust flash power level and trigger the flash. AD360II-C has 3.5mm sync cord jack and PC sync socket to achieve various sync triggering mode.
- **Wide-range accessories:** softbox, beauty dish, snoots, color gels, etc. All lighting accessories fit for barebulb flashes from most brands.

Power adjusts from full power to 1/128 in 1/3 stop increments

Stable color temperature at 5600±200K over the entire power range





1/8000s high-speed sync flash, Focus-assist beam on/off & high-speed sync triggering

The powerful and portable AD360II-C meets the demands of freelance commercial photographers, photojournalists, wedding and beach portraiture shooters, event and backpack photographers, photograph enthusiasts, etc.



For Your Safety

- ▲ Always keep this product dry. Do not use in rain or in damp conditions.
- ▲ This product contains high-voltage electronic parts. Touching the high-voltage circuit inside it may result in electric shock. Do not disassemble. Should repairs become necessary, this product must be sent to an authorized maintenance center.
- ▲ Stop using this product if it breaks open due to extrusion, falling or strong hit. Otherwise, electric shock may occur if you touch the electronic parts inside it.
- ▲ Do not fire the flash directly into the eyes (especially those of babies) within short distances. Otherwise visual impairment may occur. When taking pictures for babies, keep the flash unit at least 1 meter (3.3 feet) away from them. Using bounce flash to reduce light intensity is also recommended.
- ▲ Do not use the flash unit in the presence of flammable gases, chemicals and other similar materials. In certain circumstances, these materials may be sensitive to the strong light emitting from this flash unit and fire or electromagnetic interference may result.
- ▲ Do not leave or store the flash unit if the ambient temperature reads over 50°C (e.g. in automobile). Otherwise the electronic parts may be damaged.
- ▲ Be cautious when using the AD360II-C on your camera. AD360II-C is slightly heavy so that an AD360II-C on your camera may damage the camera hotshoe.

Contents

31	Foreword
32	For your safety
35	Name of Parts
	Body
	LCD Panel
	Included Accessories
	Separately Sold Accessories
	Installing Reflector (Other Accessories)
	Attaching Flash Tube
	Connecting to a Power Pack
	Connecting the Flash to a Camera
	Replacing the Off-Camera Adapter
39	Power Management
40	Flash Mode—E-TTL Autoflash
	 FEC (Flash Exposure Compensation)
	 FEB (Flash Exposure Bracketing)
	FEL: Flash Exposure Lock
	 High-Speed Sync
	 Second-Curtain Sync
43	Flash Mode—M: Manual Flash
44	Flash Mode—Multi/Stroboscopic Flash
45	Wireless Flash Shooting: Optic Transmission
	Wireless Settings
	Master Unit's Flash OFF
	Setting the Communication Channel
	ETTL: Fully Automatic Wireless Flash Shooting
	ETTL: Use the Wireless Shooting of Flash Ratio
	M: Wireless Flash Shooting with Manual Flash
	Multi: Wireless Flash Shooting with Manual Flash
52	Wireless Flash Shooting: Ratio (2.4G) Transmission
54	Other Applications
	Wireless Control Function
	Modeling Flash
	Auto Focus Assist Beam
	Assist Beam Setting
	Bounce Flash
	Sync Triggering
	PC Sync Socket Triggering
56	C.Fn: Setting Custom Functions
57	Control with the Camera's Menu Screen
58	Protection Function
59	Technical Data
60	Troubleshooting
60	Compatible Camera Models
60	Maintenance

Conventions used in this Manual

- This manual is based on the assumption that both the camera and camera flash's power switches are powered on.
- Reference page numbers are indicated by "p.**".
- The following alert symbols are used in this manual:
 -  The Caution symbol indicates a warning to prevent shooting problem.
 -  The Note symbol gives supplemental information.

Name of Parts

Body:

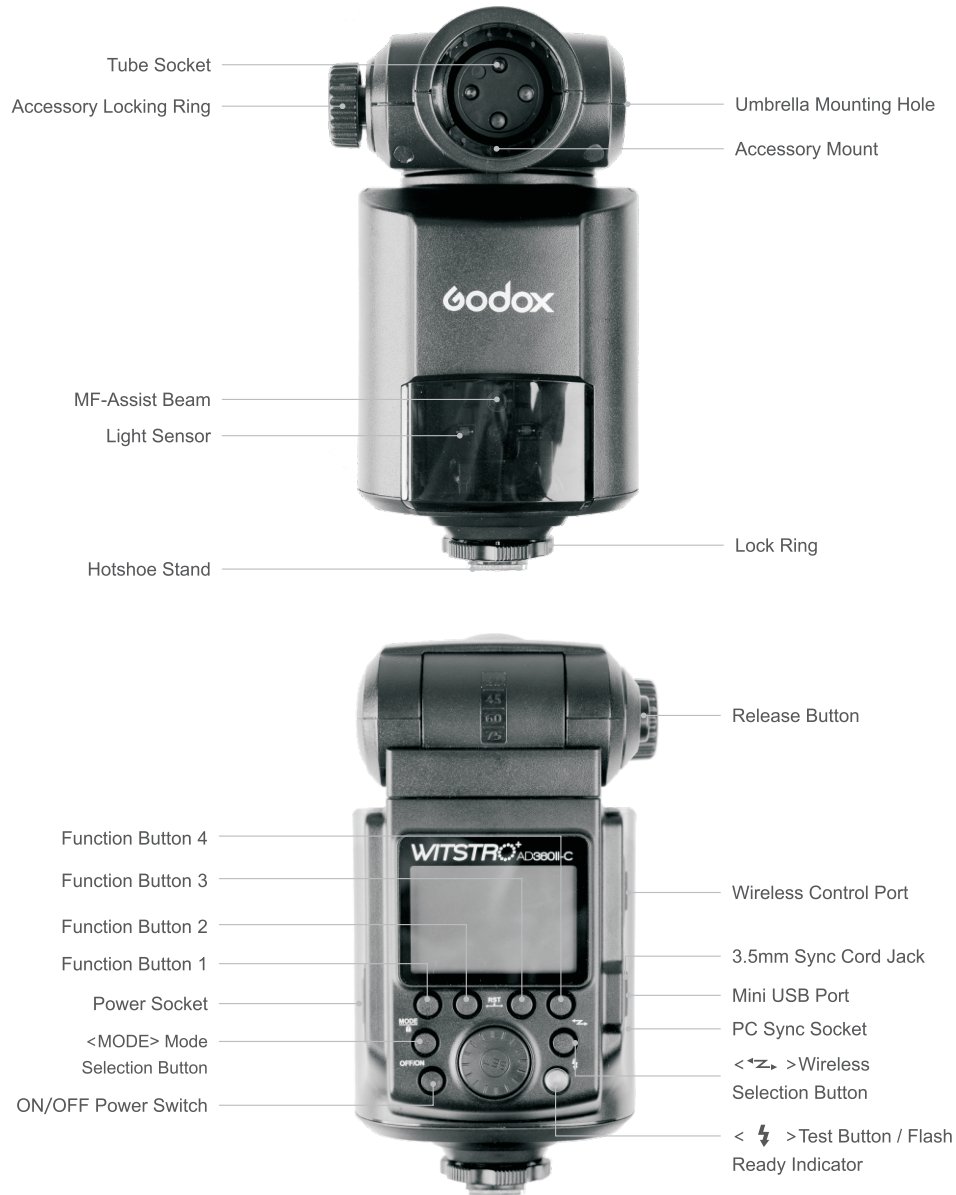

Name of Parts

LCD Panel

(1) E-TTL Autoflash

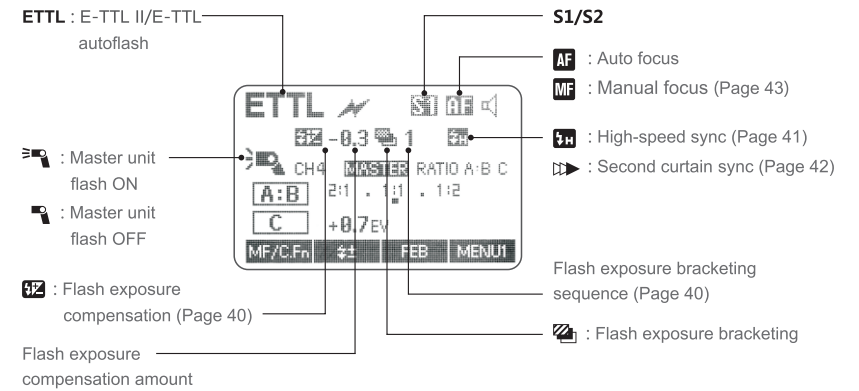

- The display will only show the settings currently applied.
- The functions displayed above function buttons 1 to 4, such as **SYNC** and **±**, change according to settings' status.
- When a button or dial is operated, the LCD panel illuminated.

(2) M Manual Flash

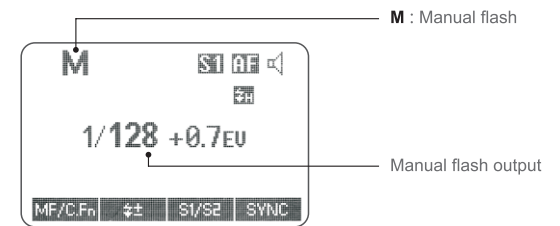

(3) Multi Flash

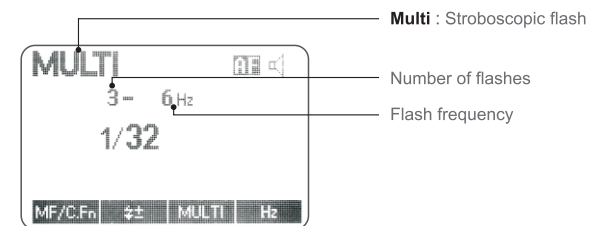

Name of Parts

(4) Radio Transmission Shooting/Optic Transmission Shooting

• Master Unit

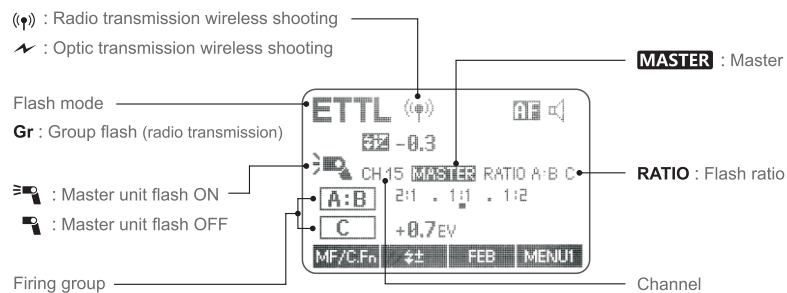

• Slave Unit

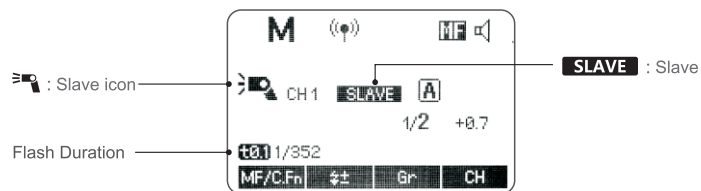

Included Accessories

- (1) Flash tube*1 (2) Protecting bag*1 (3) Mini stand*1 (4) Off-camera adapter*1 (5) Reflector*1 (6) Power cable*1 (7) Reflector diffuser*2 (8) Instruction manual*1

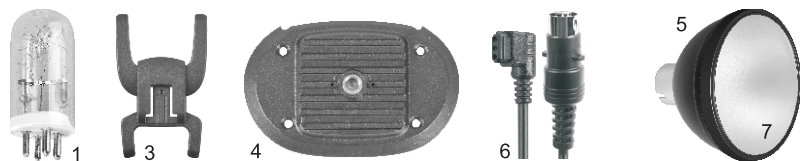

Separately Sold Accessories

The product can be used in combination with the following accessories sold separately, so as to achieve best photography effects:

X1C Wireless Flash Trigger, FT-16 Remote Control, Softbox, Beauty Dish, Fold up umbrella, Snoots, Light stand, etc.



Name of Parts

Installing Reflector (Other Accessories)

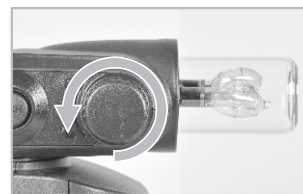

1. Rotate Accessory Locking Ring counter-clockwise until it is loosen.

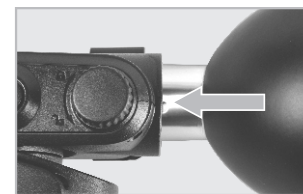

2. Insert the reflector into the Accessory Mount.

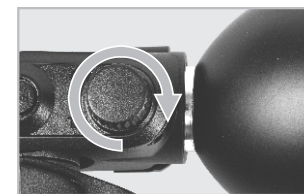

3. Rotate Accessory Locking Ring clockwise to lock it up. Do not over-tighten.

Attaching Flash Tube

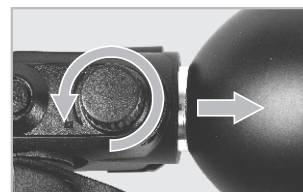

1. Remove the reflector or other accessories from the flash head.

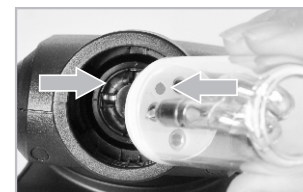

2. Match the red dot on the base of the flash tube with the red dot in the Tube Socket. Push the flash tube in until it is securely seated into the socket.

Connecting to a Power Pack



1. Before connecting, make sure that the power pack is turned off.
2. Plug one end of Power Cable into Power Socket of the flash unit, and insert the other end into the output socket of the power pack.



3. Turn on the power pack. Normally the flash unit will be fully charged and ready to work.

! The flash unit is not powered by itself, but draws power from Godox power pack PB960 (sold separately). For the instructions of the power pack, see the related user manual.

Name of Parts

Connecting the Flash to a Camera



1. Loosen the locking ring on the mounting foot.
2. Slip the mounting foot of the flash unit into the camera hotshoe.
3. Secure the flash unit by rotating the locking ring the direction of the row.

Replacing the Off-Camera Adapter

The off-camera adapter is useful when using the product as an off-camera flash. There is a 1/4" mounting hole at the bottom of the off-camera adapter. After replacing the adapter, the flash can be used mounting on GODOX AD-S13 portable light boom, AD-S16 floor light stand, and almost any other light stand. To install the off-camera adapter,



1. Use a screwdriver (not included) to remove the four screws at the bottom of this product. Then take out the bottom part carefully as illustrated.
2. Install the off-camera adapter at the bottom of this product.
3. Tighten all the screws.



Power Management

ON/OFF Power Switch controls the on/off of the flash unit. Turn off the power pack if the flash unit will not be used for an extended period (approx. 1 hour).

C.Fn Disabling Auto Power Off function is recommended when the flash is used off camera. (C.Fn-APO, Page 56)

Flash Mode — E-TTL Autoflash

This flash has three flash modes: E-TTL, Manual (M), and Multi (Stroboscopic). In E-TTL mode, the camera and the flash will work together to calculate the correct exposure for the subject and the background. In this mode, multiple TTL functions are available: FEC, FEB, FEL, HSS, second curtain sync, modeling flash, control with the camera's menu screen.

* Press <MODE> Mode Selection Button and three flash modes will display on the LCD panel one by one with each pressing.

E-TTL Mode

Press <MODE> Mode Selection Button to enter E-TTL mode. The LCD panel will display <ETTL>.

- Press the camera release button halfway to focus. The aperture will be displayed in the viewfinder.
- When the shutter button is fully pressed, the flash will fire a pre-flash that the camera will use to calculate exposure and flash output the instant before the photo is taken.

FZ FEC: Flash Exposure Compensation

With FEC function, this flash can adjust from -3 to +3 in 1/3rd stops. It is useful in situations where minor adjusting of the TTL system is needed based on the environment.

Setting FEC:

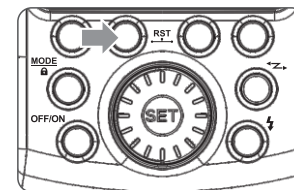

- 1 Press Function Button 2 <FZ>. The icon <FZ> and flash exposure compensation amount will be highlighted on the LCD panel.

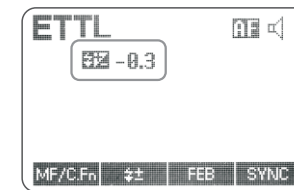

- 2 Set the flash exposure compensation amount.
 - Turn the Select Dial to set the amount.
 - "0.3" means 1/3 step, "0.7" means 2/3 step.
 - To cancel the flash exposure compensation, set the amount to "+0".

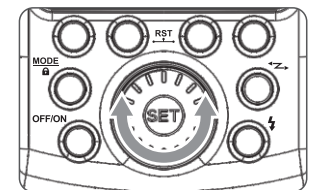



- 3 Press <SET> button again to confirm the setting.

FZ FEB: Flash Exposure Bracketing

You can take three flash shots while automatically changing the flash output for each shot from -3 to +3 in 1/3rd stops. The camera will record three images with different exposures: one exposed according to camera calculations, one over-exposed and another under-exposed. Over and under exposure amount is user adjustable. This function helps get correct exposure especially in shooting moving objects or when environmental lights are complex.

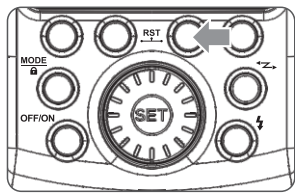
Flash Mode — E-TTL Autoflash



1 Press function button 3 < FEB >. The icon <  > and the exposure bracketing amount will be highlighted on the LCD panel.

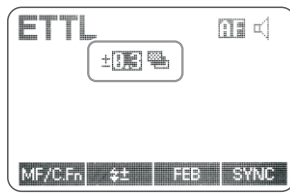

2 Set the exposure bracketing amount.

- Turn the Select Dial to set the amount.
- "0.3" means 1/3 step,
- "0.7" means 2/3 step.

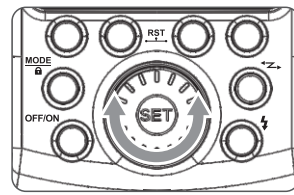

3 Press <SET> button again to confirm the setting. Then the FEC and FEB settings are displayed on the LCD panel.

- FEB will be cancelled after three photos are taken.
- For best results, set the camera drive mode to "single" and ensure the flash is ready before shooting.
- FEB can be used with FEC and FEL.
- C.Fn** You can prevent the FEB from being cancelled automatically after three photos are taken. (C.Fn-FEB ACL, Page 56)
- C.Fn** The FEB shooting sequence can be changed. (C.Fn-FEB, Page 56)

FEL: Flash Exposure Lock

FEL can lock the correct flash exposure setting for any part of the scene.

With <ETTL> displayed on the LCD panel, press the camera's <FEL> button. If the camera does not have the <FEL> button, press the < * > button.

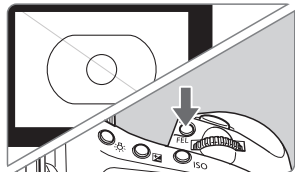

- 1** Focus the subject.
- 2** Press the <FEL> button.
 - Aim the subject at the center of the viewfinder and press <FEL> button.
 - The camera flash will fire a preflash and the required flash output for the subject is retained in memory.
 - Each time the <FEL> button is pressed, a preflash will be fired and a new flash exposure setting will be locked.

- If the subject is too far away and underexposure, the <  > icon will blink in the viewfinder. Move closer to the subject and try the FE lock again.
- If <ETTL> is not displayed on the LCD panel, FE lock cannot be set.
- If the subject is too small, FE lock might not be very effective.

High-Speed Sync

High Speed Sync (FP flash) enables the flash to synchronize with all camera shutter speeds. This is convenient when you want to use aperture priority for fill-flash portraits.

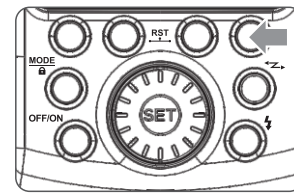

Flash Mode — E-TTL Autoflash

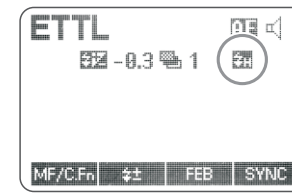

1 Press Function Button 4 < SYNC > so that <  > is displayed.



2 Check that <  > is displayed in the viewfinder.

- If you set a shutter speed that is the same as or slower than the camera's maximum flash sync speed, <  > will not be displayed in the viewfinder.
- With high-speed sync, the faster the shutter speed, the shorter the effective flash range.
- To return to normal flash, press < SYNC > button again. Then <  > will disappear.
- Multi flash mode cannot be set in high-speed sync mode.
- Over-temperature protection may be activated after 30 consecutive high-speed sync flashes.

Second-Curtain Sync

With a slow shutter speed, you can create a light train following the subject. The flash fires right before the shutter closes. Press function button 4 < SYNC > button so that <  > is displayed on the LCD panel.

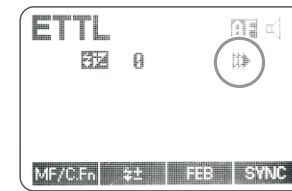
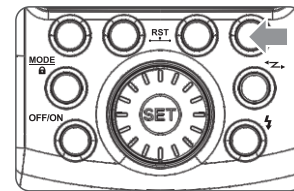

Flash Mode — M: Manual Flash

The flash output is adjustable from 1/1 full power to 1/128th power in 1/3rd stop increments. To obtain a correct flash exposure, use a hand-held flash meter to determine the required flash output.

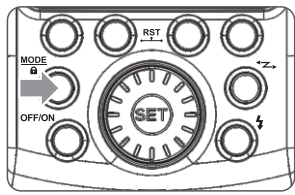

1 Press <MODE> button so that <M> is displayed.

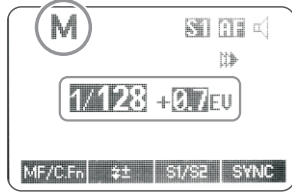

2 Turn the Select Dial to choose a desired flash output amount.

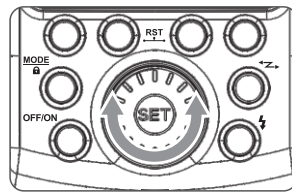

3 Press <SET> button again to confirm the setting.

Flash Output Range

The following table makes it easier to see how the stop changes in terms of f/stop when you increase or decrease the flash output. For example, when you decrease the flash output to 1/2, 1/2-0.3, or 1/2-0.7, and then increase the flash output to more than 1/2, 1/2+0.3, 1/2+0.7, and 1/1 will be displayed.

Figures displayed when reducing flash output level→

1/1	1/1-0.3	1/1-0.7	1/2	1/2-0.3	1/2-0.7	1/4
	1/2+0.7	1/2+0.3		1/4+0.7	1/4+0.3	

←Figures displayed when increasing flash output level

Optic S1 Secondary Unit Setting

In M manual flash mode, press <S1/S2> button so that this flash can function as an optic S1 secondary flash with optic sensor. With this function, the flash will fire synchronously when the main flash fires, the same effect as that by the use of radio triggers. This helps create multiple lighting effects.

Optic S2 Secondary Unit Setting

Press <S1/S2> button so that this flash can also function as an optic S2 secondary flash with optic sensor in M manual flash mode. This is useful when cameras have pre-flash function. With this function, the flash will ignore a single "preflash" from the main flash and will only fire in response to the second, actual flash from the main unit.

- S1 and S2 optic triggering is only available in M manual flash mode.

Display Flash Duration

Flash duration refers to the length of time that from flash's firing to reach the half peak at maximum. The half peak at maximum is usually expressed as $t=0.5$. In order to provide the photographer with more concrete data, this product adopts $t=0.1$. The difference between $t=0.5$ and $t=0.1$ is shown in the following picture.

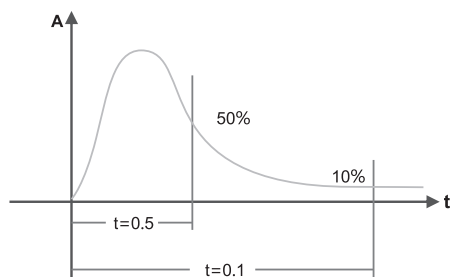

In M/Multi mode which without high-speed sync, flash duration is displayed on the LCD panel.



Flash Mode — Multi: Stroboscopic Flash

With stroboscopic flash, a rapid series of flashes is fired. It can be used to capture a multiple images of a moving subject in a single photograph.

You can set the firing frequency (number of flashes per sec. expressed as Hz), the number of flashes, and the flash output.

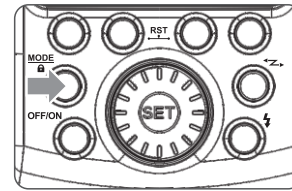

1 Press <MODE> button so that <MULTI> is displayed.

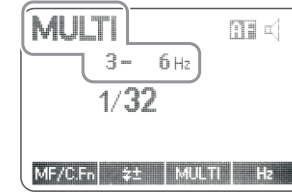

- 2 Set the flash frequency and flash times.
- Press Function **Button 3** <MULTI> button to select the flash times. Turn the Select Dial to set the number.
 - Press Function **Button 4** <Hz> button to select the flash times. Turn the Select Dial to set the number.
 - After you finish the setting, press <SET> button and all the settings will be displayed.

Calculating the Shutter Speed

During stroboscopic flash, the shutter remains open until the firing stops. Use the formula below to calculate the shutter speed and set it with the camera.

Number of Flashes / Flash Frequency = Shutter Speed

For example, if the number of flashes is 10 and the firing frequency is 5 Hz, the shutter speed should be at least 2 seconds.

- ⚠ To avoid overheating and deteriorating the flash head, do not use stroboscopic flash more than 10 times in succession. After 10 times, allow the camera flash to rest for at least 15 minutes. If you try to use the stroboscopic flash more than 10 times in succession, the firing might stop automatically to protect the flash head. If this happens, allow at least 15 minutes' rest for the camera flash.

- Stroboscopic flash is most effective with a highly reflective subject against a dark background.
- Using a tripod and a remote control is recommended.
- A flash output of 1/1 and 1/2 cannot be set for stroboscopic flash.
- Stroboscopic flash can be used with "buLb".
- If the number of flashes is displayed as "--", the firing will continue until the shutter closes or the battery is exhausted. The number of flashes will be limited as shown by the following table.

Maximum Stroboscopic Flashes:

Flash Output \ Hz	1	2	3	4	5	6-7	8-9	10	11	12-14	15-19	20-50	60-199
1/4	7	6	5	4	4	3	3	2	2	2	2	2	2
1/8	14	14	12	10	8	6	5	4	4	4	4	4	4
1/16	30	30	30	20	20	20	10	8	8	8	8	8	8
1/32	60	60	60	50	50	40	30	20	20	20	18	16	12
1/64	90	90	90	80	80	70	60	50	40	40	35	30	20
1/128	100	100	100	100	100	90	80	70	70	60	50	40	40

If the number of flashes is displayed as "--", the maximum number of flashes will be as shown in the following table regardless of the flash frequency.

Flash Output	1/4	1/8	1/16	1/32	1/64	1/128
Number of Flashes	2	4	8	12	20	40

Wireless Flash: Optic Transmission

This product supports wireless flash application and functions as either a master or a slave unit. As a master unit, it can control Canon speedlites e.g. 580EXII, 600EX-RT via wireless. As a slave unit, it can receive wireless signals of Canon speedlites e.g. 580EXII, 600EX-RT and commanders of Canon cameras e.g. 7D/60D/600D.

- You can set up two to three slave groups for E-TTL II autoflash shooting. With E-TTL II autoflash, you can easily create various lighting effects.
- Any flash settings (of flash exposure compensation, high-speed sync, FE lock, FEB, manual flash, Multi flash) on the master unit will be automatically sent to the slave units. So the only thing you need to do is to set the master unit to E-TTL mode without any operation for the slave units at all during the shooting.
- This flash can work in E-TTL autoflash, M manual flash, and Multi stroboscopic flash modes when set as a master unit.

Positioning and Operation Range

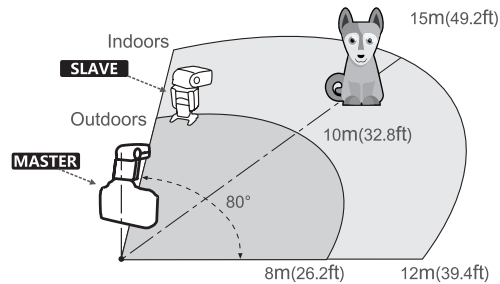

- Even with multiple slave units, the master unit can control all of them via wireless.
- In this user manual, "master unit" refers to the camera flash on a camera and "slave unit" will be controlled by the master unit.

1. Wireless Settings

You can switch between normal flash and wireless flash. For normal flash shooting, be sure to set the wireless setting to OFF.

Master Unit Setting

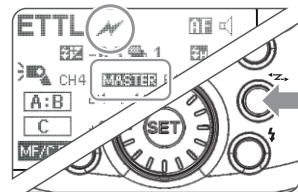

Press < > button so that < > or < MASTER > are displayed on the LCD panel.

Slave Unit Setting

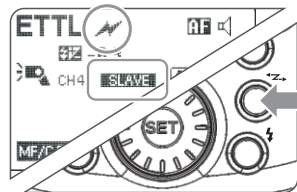

Press < > button again so that < > or < SLAVE > are displayed on the LCD panel.

Wireless Flash: Optic Transmission

2. Master Unit's Flash OFF

When the master unit is set to OFF, only the slave units will fire a flash.

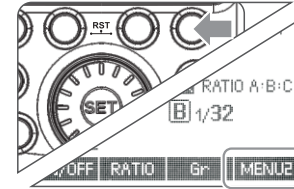

1 Press Function Button 4 so that < MENU2 > is displayed on the LCD panel.

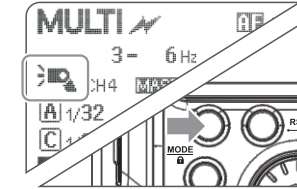

2 Press Function Button 1 < ON/OFF > to control the ON/OFF of the master unit.
 < > : The master unit flash firing is ON.
 < > : The master unit flash firing is OFF.

- Even if the master unit flash firing is disabled, it still fires a preflash to transmit wireless signals.

3. Setting the Communication Channel

If there are other wireless flash systems nearby, you can change the channel IDs to prevent signal interference. The channel IDs of the master unit and the slave unit(s) must be set to the same.

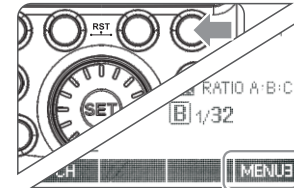

1 Press Function Button 4 so that < MENU3 > is displayed on the LCD panel.

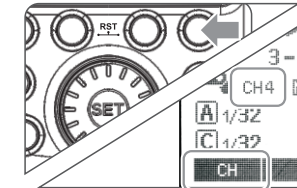

2 Press Function Button 1 so that < CH > is displayed on the LCD panel. Turn the Select Dial to choose a channel ID from 1 to 4.

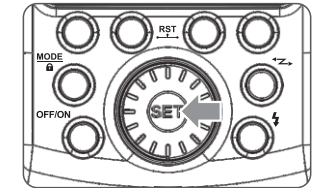

3 Press the < SET > button to confirm.

Wireless Flash: Optic Transmission

4. E TTL: Fully Automatic Wireless Flash Shooting

Using Automatic Wireless Flash with a Single Slave Unit

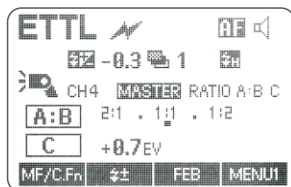

1 Master Unit Setting

- Attach a AD360II-C camera flash on the camera and set it as the master unit.
- As a master unit, AD360II-C can control Canon speedlites e.g. 580EXII, 600EX-RT via wireless.

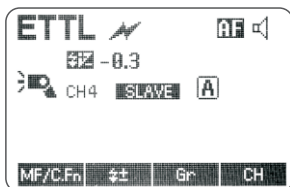

2 Slave Unit Setting

- Set the other camera flash as the wireless slave unit.
- As a slave unit, AD360II-C can receive wireless signals of Canon speedlites e.g. 580EXII, 600EX-RT and commanders of Canon cameras e.g. 7D/60D/600D.

3 Check the communication channel.

- If the master unit and slave unit(s) are set to a different channel, set them to the same channel. (Page 46)

4 Position the camera and flashes.

- Position the camera and flashes as the picture shows. (Page 45)

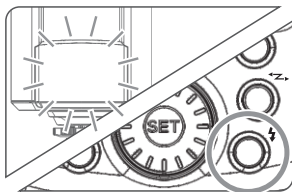

5 Set the master unit's flash mode to <E TTL>.

- Set the master unit's flash mode to <E TTL>.
- For shooting, <E TTL> will automatically be set for the slave unit.
- Set the master unit flash firing as ON to fire a flash.

6 Check that the flash is ready.

- Check that the master flash ready indicator is lightened.
- When the slave flash ready indicator is ready, the AF-assist beam lighting area will blink at 1 second intervals.

7 Check the flash operation.

- Press the master unit's Test Button < ⚡ >.
- Then, the slave unit will fire. If not, adjust the slave unit's angle toward the master unit and distance from the master unit.

Wireless Flash: Optic Transmission

Using Automatic Wireless Flash with Multiple Slave Units

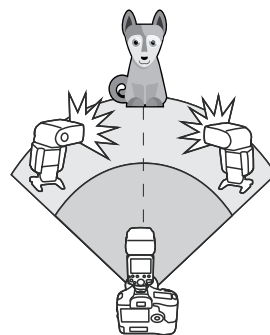

When stronger flash output or more convenient lighting operation is needed, increase the number of slave units and set it as a single slave unit.

To add slave units, use the same steps as setting "automatic wireless flash with a single slave unit". Any flash group can be set (A/B/C).

When the number of slave units is increased and the master unit flash firing is ON, automatic control is implemented to make all groups of flashes fire the same flash output and ensure the total flash output up is to standard exposure.

⚠ The slave unit might be out of order or fire an unwanted flash due to the nearby fluorescent lamp or computer screen.

- Press the depth-of-field preview button on the camera to fire a modeling flash.
- If the slave unit's auto power off function is workable, press the master unit's test button to power it on. Please note that test firing is unavailable during the camera's regular metering time.
- By making some settings, the auto AF-assist transmitter will not blink after the slave unit's flash ready indicator is lightened. (C.Fn-AF/ Page 56)

Using Fully Automatic Wireless Flash

The FEC and other settings that set on the master unit will also be appeared on the slave unit automatically. The slave unit does not need any operation. Use the following settings to make wireless flashes according to the same methods with normal flash shooting.

- Flash Exposure Compensation (**±** / Page 40)
- High-Speed Sync (**SYNC** / Page 41)
- Flash Exposure Bracketing(**FEB** / Page 40)
- Manual Flash (Page 43)
- Flash Exposure Lock(Page 41)
- Stroboscopic Flash (Page 44)

⚠ The firing frequency of stroboscopic flash during the optic transmission shooting can be set from 1Hz to 199Hz.

i Press Function Button 4 so that < **±** >, < **SYNC** > or < **FEB** > are displayed.

About Master Unit

Use two or more master units. By preparing several cameras that with master units flash attached, cameras can be changed in shooting while keeping the same lighting source (slave unit).

Wireless Flash: Optic Transmission

5. E-TTL: Use the Wireless Shooting of Flash Ratio

Autoflash Shooting with Two Slave Unit

Divide the slave units into A and B groups and balance their shooting illumination (flash ratio).
Auto control exposure to make the total output of A and B flash groups up to standard exposure.

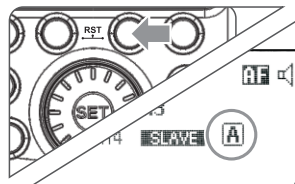

1 Setting the flash groups of slave unit.

- Set the flash as slave unit.
- Press Function Button 3 < Gr > and choose < A > or < B >.
- Set one slave unit as < A >, the other as < B >.

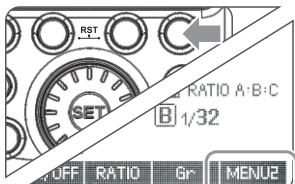

2 Setting < MENU 2 >.

- Step 2 to Step 4 are set on the master unit.
- Press the Function Button 4 on the master unit so that < MENU 2 > is displayed.

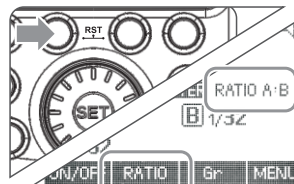

3 Setting < RATIO A:B >.

- Press Function Button 2 < RATIO > so that < RATIO A:B > is displayed.

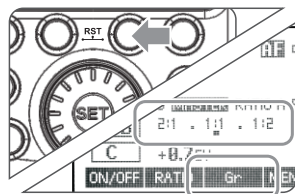

4 Setting flash ratio.

- Press Function Button 3 < Gr >.
- Turn the Select Dial to set the amount of flash ratio and press < SET > button to confirm.

5 Taking the picture.

- The slave units will flash according to the flash ratio.

Autoflash Shooting with Three Slave Unit

You can add firing group C to firing groups A and B. C is convenient to set lighting so as to eliminate the subject's shadow. The basic setting method is the same as "Autoflash Shooting with Two Slave Unit".

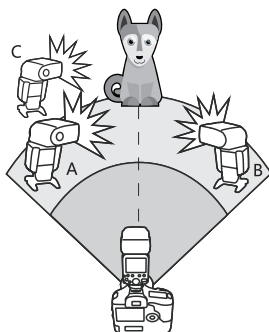

1 Setting the slave group < C >.

- Use the same method of step 1 (page 49) to set the slave unit of flash group < C >.

2 Setting < RATIO A:B C >.

- Use the same method of step 2 and step 3 (see page 49) to set the master unit as < RATIO A:B C >.

3 Setting flash exposure compensation.

- Use the same method of step 1 (page 49) to set the slave unit of flash group < C >.
- Press Function Button 2 < +/- >. Turn the Select Dial to set the amount of flash exposure compensation and press < SET > button to confirm.

Wireless Flash: Optic Transmission

About Slave Group Control

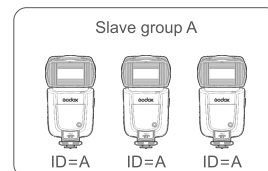

If three slave units are all set to < A > in terms of slave ID, these slave units will be controlled as if they were one camera flash in slave group A.

- When setting < RATIO A:B C >, group A, B and C will fire a flash synchronously; when setting < RATIO A:B >, group C will not fire a flash.
- If shooting under the situation that group C is toward the main shooting subject, over exposure might occurred.
- In some EOS film cameras that support E-TTL autoflash, you cannot perform multiple flash wireless shooting with a flash ratio setting.

- The flash ratio of 8:1 to 1:1 to 1:8 is equivalent to 3:1 to 1:1 to 1:3 (1/2 step increment).
- The details of the flash ratio settings are as follows.



6. M: Wireless Flash Shooting with Manual Flash

This describes wireless (multiple shooting) using manual flash. You can shoot with a different flash output setting for each slave unit (firing group). Set all parameters on the master unit.

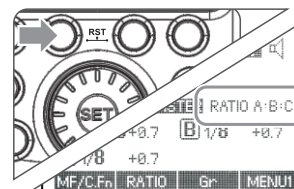

1 Setting the flash mode to < M >.

2 Setting the number of flash groups.

- When < MENU 1 > is displayed, press the Function Button 2 < RATIO > to set the groups to fire.
- The setting changes as follows each time you press the button:
ALL (RATIO OFF) →
A/B (RATIO A:B) →
A/B/C (RATIO A:B:C).

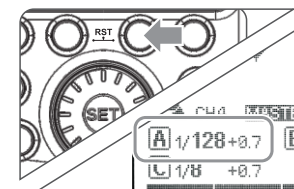

3 Setting flash output.

- Press Function Button 3 < Gr >. Turn the Select Dial to set the flash output of the groups. Press < SET > button to confirm.

4 Taking the picture.

Each group fires at the set flash ratio.

- When ALL < RATIO OFF > is set, set A, B or C as the firing group for the slave units.
- To fire multiple slave units with the same flash output, select ALL < RATIO OFF > in step 2.

Wireless Flash: Optic Transmission

Setting <M> Flash Mode

You can directly operate the slave unit to manually set the manual flash or stroboscopic flash.

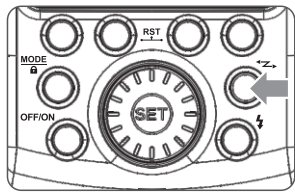

1 Setting the slave unit. (Page 45)

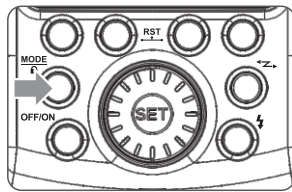

2 Setting flash mode to <M>.

- Press <MODE> button so that <M> is displayed.
- Set the manual flash output. (Page 43)

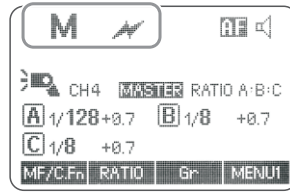

7. Multi: Wireless Flash Shooting with Manual Flash

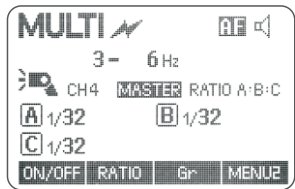

Setting <MULTI> stroboscopic flash.

- Press <MODE> button so that <MULTI> is displayed.
- Setting the stroboscopic flash. (Page 44)

⚠ The firing frequency of stroboscopic flash during the optic transmission wireless shooting can be set from 1Hz to 199Hz.

Wireless Flash Shooting: Radio (2.4G) Transmission

Using a flash (master/slave) with a radio transmission wireless shooting function make it easy to shoot with advanced wireless multiple flash lighting, in the same way as E-TTL II autoflash shooting.

The basic relative position and operation range are as shown in the picture. You can then perform wireless E-TTL II /ETTL autoflash shooting just by setting the master unit to <ETTL>.

AD360II-C adopts Godox 2.4G wireless X system, which can be used in combination with other products in our factory.

As a slave unit, AD360II-C is compatible with Canon E-TTL II and Nikon i-TTL systems. It will automatically change its system according to the master unit instead of setting by manual. Once received the master unit's signal, "Canon" or "Nikon" is displayed the LCD panel.

Nikon cameras (use X1T-N, TT685N, etc) and Canon cameras (use X1T-C, TT685C, etc) can use one or more AD360II-C flashes simultaneously.



* As master unit, AD360II-C can control the following slave units: AD360II-C, AD360II-N, TT685C, X1R-C, TT600, etc.

* As slave unit, AD360II-C can be controlled by the following master units: AD360II-C, AD360II-N, TT685C, TT685N, X1T-C, X1T-N, TT600, etc.

Positioning and Operation Range (Example of wireless flash shooting)

- Autoflash Shooting with One Slave Unit

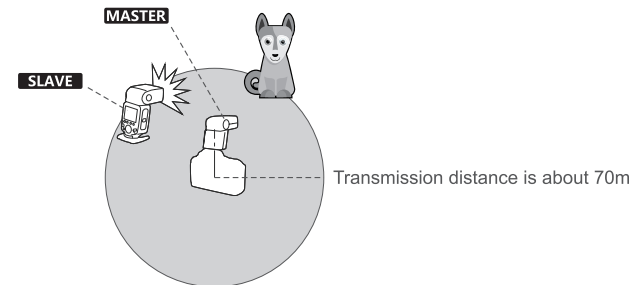

- Use the supplied mini stand to position the slave unit.
- Before shooting, perform a test flash and test shooting.
- The transmission distance might be shorter depending on the conditions such as positioning of slave units, the surrounding environment and whether conditions.

Wireless Flash Shooting: Radio (2.4G) Transmission

Wireless Multiple Flash Shooting

You can divide the slave units into two or three groups and perform E-TTL II/E-TTL autoflash while changing the flash ratio (factor). In addition, you can set and shoot with a different flash mode for each firing group, for up to 5 groups.

• Auto Shooting with Two Slave Groups

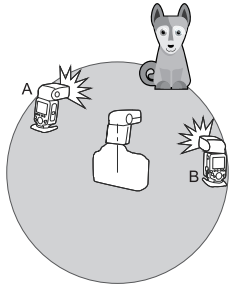

• Auto Shooting with Three Slave Groups

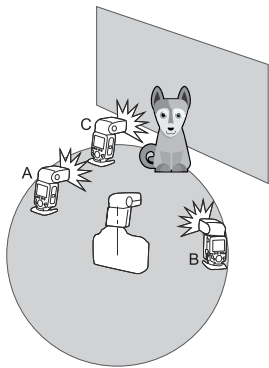

Wireless shooting using radio transmission has advantages over wireless shooting using optic transmission, such as being less affected by obstacles, and not having to point the slave unit's wireless sensor toward the master unit. The main functional differences are as follows:

Function	Radio Transmission	Optic Transmission
Distance	70m	Master (transmitter): approx. 3m; Slave (receiver): approx. 15m
Channel	1~32	1~4
A/B/C Power	OFF, 1/128~1/1	1/128~1/1
To be disturbed	Hard	Easy

Other Applications

Wireless Control Function

The flash unit is built in with a Wireless Control Port so that you can wirelessly adjust the power level of the flash and the flash triggering. To control the flash wirelessly, you need a FT-16 remote control set (on-camera and on-flash). Insert its receive end into the Wireless Control Port on the flash and insert the transmit end into the camera hot shoe. Settings made on the hotshoe-mounted transmit and receive ends will be wirelessly communicated to the flash. Then you can press the camera shutter release button to trigger the flash. You can also hold the transmit end at hand to control your off-camera flash.

 For full instructions on the use of FT series remote control, see its user manual.

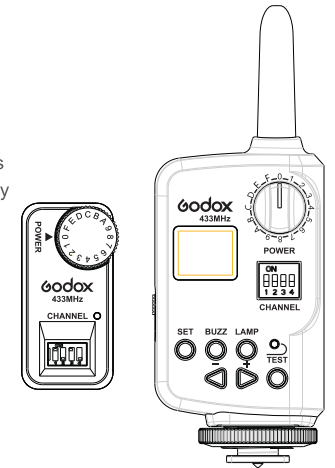

Modeling Flash

If the camera has a depth-of-field preview button, pressing it will fire the flash continuously for 1 second. This is called modeling flash.

It enables you to see the shadow effects on the subject and the lighting balance. You can fire the modeling flash during wireless or normal flash shooting.

 • To avoid overheating and deteriorating the flash head, do not fire the modeling flash for more than 10 consecutive times. If you fire the modeling flash 10 consecutive times, allow at least 10 minutes' break for the camera flash.
• The modeling flash cannot be fired with the EOS 300 and Type-B cameras.

Auto Focus Assist Beam

In poorly-lit or low-contrast shooting environments, the built-in auto focus assist beam will automatically light on to make it easier for autofocus. The beam will light up only when autofocus is difficult and get out as soon as the autofocus becomes correct.

If you want to turn off the auto focus assist beam, set the "AF" to "OFF" on the C.Fn settings.

 If you find the auto focus assist beam does not light up, this is because the camera has got a correct autofocus.

Position	Effective Range
Center	0.6~10m / 2.0~32.8 feet
Periphery	0.6~5m / 2.0~16.4 feet

Assist Beam Setting

The flash has two ways to light on the assist beam: auto focus (AF) and manual focus (MF). Press Function Button 1 (MF/C.Fn) to choose.

Auto focus (AF): The assist beam is lighted on by camera.

Manual focus (MF): The assist beam is lighted on manually.

Turn off the assist beam: Set "AF" to OFF on the C.Fn menu, and the assist beam will be turned off.

Other Applications

Bounce Flash

By pointing the flash head toward a wall or ceiling, the flash will bounce off the surface before illuminating the subject. This can soften shadows behind the subject for a more natural-looking shot. This is called bounce flash.

To set the bounce direction, hold the flash head and turn it to a satisfying angle.

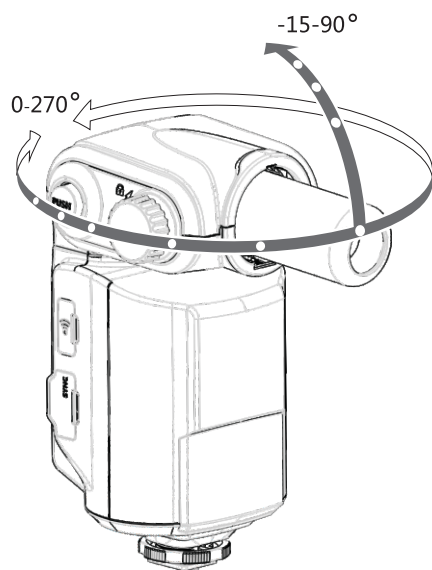

- i** • If the wall or the ceiling is too far away, the bounced flash might be too weak and result in underexposure.
- The wall or the ceiling should be a plain, white color for high reluctance. If the bounce surface is not white, a color cast may appear in the picture.

Sync Triggering

The Sync Cord Jack is a $\Phi 3.5\text{mm}$ plug. Insert a trigger plug here and the flash will be fired synchronously with the camera shutter.

PC Sync Socket Triggering

Use remote cable to connect the camera and the AD360II-C through its PC sync socket, and the flash will be fired synchronously with the camera shutter.

C.Fn: Setting Custom Functions

The following table lists the available and unavailable custom functions of this flash.

Custom Function Signs	Functions	Setting Signs	Settings & Descriptions	Custom Functions No.
APO	Auto power off	ON	ON	C.Fn-01
		OFF	OFF	
FEB ACL	FEB auto cancel	ON	ON	C.Fn-03
		OFF	OFF	
FEB	FEB order	0 → - → +		C.Fn-04
		- → 0 → +		
AF	AF-assist beam	ON	ON	C.Fn-08
		OFF	OFF	
BEEP	Beeper	ON	ON	C.Fn-20
		OFF	OFF	
LIGHT	Backlighting time	12sec	Off in 12 sec.	C.Fn-22
		OFF	Always off	
		ON	Always lighting	
LCD	LCD contrast ratio	0~9	10 levels	

1. Press < MF/C.Fn > Button for 2 seconds or longer until C.Fn menu is displayed. The "Ver x.x" in the top-right corner refers to the software version.
2. Select the Custom Function No.
 - Turn the Select Dial to select the Custom Function No.
3. Change the Setting.
 - Press < SET > button and the Setting No. blinks.
 - Turn the Select Dial to set the desired number. Pressing < SET > button will confirm the settings.
 - After you set the Custom Function and press < MODE > button, the camera will be ready to shoot.
4. In the C.Fn states, long press the "Clear" button for 2 seconds until "OK" is displayed on the panel, which means the values in C.Fn can be reset.

Control with the Camera's Menu Screen

If the camera flash is attached to an EOS camera which has a speedlite control function, the flash can be controlled using the camera's menu screen. For the menu operation procedure, refer to your camera's instruction manual.

Setting Camera Flash Functions

The following flash functions are settable according to different flash modes.

1. Flash mode
2. Shutter sync (1st/2nd curtain, high speed sync)
3. FEB
4. Flash exposure compensation
5. Flash firing
6. Clear camera flash's settings

Custom Functions of Camera Flash

C.Fn-01, C.Fn-03, C.Fn-04, C.Fn-08, C.Fn-20, and C.Fn-22.

Clear All Flash Custom Functions

Flash function settings screen

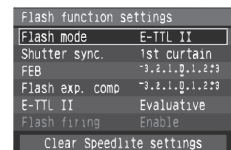

Flash C.Fn settings screen

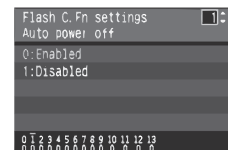

*Screens from the EOS-1D Mark III.

- If flash exposure compensation has already been set with the camera flash, flash exposure compensation cannot be set with the camera. To set it with the camera, the camera flash's flash exposure compensation must be set to zero.
- If any Flash Custom Functions and flash settings other than flash exposure compensation have been set by both the camera and the flash, the latest settings will take effect.

Protection Function

1. Over-Temperature Protection

- To avoid overheating and deteriorating the flash head, do not fire more than 75 continuous flashes in fast succession at 1/1 full power. After 30 continuous flashes, allow a rest time of at least 75 minutes.
- If you fire more than 75 continuous flashes and then fire more flashes in short intervals, the inner over-temperature protection function may be activated and make the recycling time over 10 seconds. If this occurs, allow a rest time of about 10 minutes, and the flash unit will then return to normal.
- When the over-temperature protection is started, U is shown on the LCD display.

Number of flashes that will activate over-temperature protection:

Power Output Level	Number of Flashes
1/1	75
1/2(+0.3,+0.7)	100
1/4(+0.3,+0.7)	150
1/8(+0.3,+0.7)	200
1/16(+0.3,+0.7)	300
1/32(+0.3,+0.7)	500
1/64(+0.3,+0.7)	1000
1/128(+0.3,+0.7)	

Number of flashes that will activate over-temperature protection in high-speed sync triggering mode:

Power Output	Times
1/1	30
1/2(+0.3,+0.7);	40
1/4(+0.3,+0.7)	50
1/8(+0.3,+0.7);	60
1/16(+0.3,+0.7)	75
1/32(+0.3,+0.7);	
1/64(+0.3,+0.7);	100
1/128(+0.3,+0.7);	

2. Other Protections

- The system provides real-time protection to secure the device and your safety. The following lists prompts for your reference:

LCD Panel	Meaning
E1	A failure occurs on the recycling system so that the flash cannot fire. Please restart the flash unit. If the problem still exists, please send this product to a maintenance center.
E2	The system gets excessive heat. Please allow a rest time of 10 minutes.
E3	The voltage on two outlets of the flash tube is too high. Please send this product to a maintenance center.
E9	There are some errors occurred during the upgrading process. Please using the correct firmware upgrade method.

Technical Data

Model	AD360II-C	
•Type		
Compatible Cameras	Canon EOS cameras (E-TTL II autoflash)	
Slave Unit Compatible Cameras	Canon EOS cameras, E-TTL II autoflash (master unit use TTL wireless flash trigger X1C, etc.) Nikon cameras, i-TTL autoflash (master unit use TTL wireless flash trigger use X1N, etc.)	
Guide No. (m ISO 100)	80 (m ISO 100, with AD-S2 standard reflector)	
Vertical Rotation Angle	-15° to 90°	
Horizontal Rotation Angle	0 to 270°	
Flash Duration	1/220 to 1/10000 seconds	
•Exposure Control		
Exposure control system	E-TTL II autoflash and manual flash	
Flash exposure compensation (FEC)	Manual. FEB: ±3 stops in 1/3 stop increments (Manual FEC and FEB can be combined.)	
FE lock	With < FEL > button or < ★ > button	
Sync mode	High-speed sync (up to 1/8000 seconds), first-curtain sync, and second-curtain sync	
Multi flash	Provided (up to 100 times, 199Hz)	
•Wireless Flash (Optic transmission and 2.4G transmission)		
Wireless flash function	Master, Slave, Off	
Controllable slave groups	3 (A, B, and C)	
Transmission range (approx.)	Optic	Master (transmitter): approx. 3m; Slave (receiver): Indoors: 12 to 15 m/ 39.4 to 49.2 ft.; Outdoors: 8 to 10 m/ 26.2 to 32.8ft. Master unit reception angle:±40° ; horizontally, ±30° vertically
	2.4G	70m (AD360II-C as a transmitter) 100m (X1C/X1N as a transmitter)
Channels	Optic	4 (1, 2, 3, and 4)
	2.4G	32 (1~32)
Modeling flash	Fired with camera's depth-of-field preview button	
•Auto Focus Assist Beam		
Effective range (approx.)	Center: 0.6~10m / 2.0~32.8 feet Periphery: 0.6~5m / 2.0~16.4 feet	
•Power Supply		
Power Supply	GODOX PB960 lithium power pack	
Full Power Flashes	450 (with PB960 power pack)	
Recycle Time	Approx. 0.05-4.5s (with PB960 power pack)	
Power Saving	Power off automatically after approx. 90 seconds of idle operation. (60 minutes if set as slave)	
•Sync Triggering Mode	Hotshoe, 3.5mm sync line, PC sync socket, Wireless control port	
•Color Temperature	5600±200k	
•Dimensions		
Dimension	75*95*220mm (flash tube & reflector not included)	
Net Weight	800g (flash tube & reflector not included)	

Troubleshooting

If there is a problem, refer to this Troubleshooting Guide.

The Camera Flash does not fire.

- The camera flash is not attached securely to the camera.
→ Attach the camera's mounting foot securely to the camera.
- The electrical contacts of the Camera Flash and camera are dirty.
→ Clean the contacts.
- < > or < > is not displayed in the view finder of camera.
→ Wait until the flash is fully recycled and the flash ready indicator lights up.
→ If the flash ready indicator lights up, but < > or < > is not displayed in the view finder, check whether this flash unit is securely attached to the camera hotshoe.

The flash exposure is underexposed or overexposed.

- There was a highly reflective object (e.g. glass window) in the picture.
→ Use FE lock (FEL).
- You used high-speed sync.
→ With high-speed sync, the effective flash range will be shorter. Make sure the subject is within the effective flash range displayed.
- You used Manual Flash mode.
→ Set the flash mode to E-TTL or modify the flash output.

This flash supports firmware upgrade through the USB port. Update information will be released on our official website.

USB connection line is not included in this product. The USB port is a standard Micro USB socket. Common USB connection line is applicable.

Compatible Camera Models

This flash unit can be used on the following **Canon EOS series camera models:**

5D Mark III	5D Mark II	6D	7D	
60D	50D	40D	30D	650D
600D	550D	500D	450D	
400D Digital	1100D	1000D		

• This table only lists the tested camera models, not all Canon EOS series cameras. For the compatibility of other camera models, a self-test is recommended.
• Rights to modify this table are retained.

Maintenance

- Shut down the device immediately should abnormal operation be detected.
- Avoid sudden impacts and the product should be dedusted regularly.
- It is normal for the flash tube to be warm when in use. Avoid continuous flashes if unnecessary.
- Maintenance of the flash must be performed by our authorized maintenance department which can provide original accessories.
- This product, except consumables e.g. flash tube, is supported with a one-year warranty.
- Unauthorized service will void the warranty.
- If the product had failures or was wetted, do not use it until it is repaired by professionals.
- Changes made to the specifications or designs may not be reflected in this manual.